

Diamond & CBN Wheels

Diamond wheels are mainly suitable for rough grinding, semi- micro- finishing, micro finishing, polishing, grinding, cutting of hard alloy, magnetic material, mould and measuring tool, knife and cutting tool, glass, stone material and ferrite work piece.

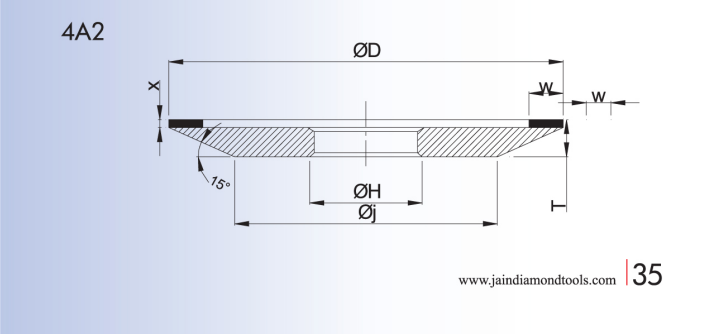

4F4

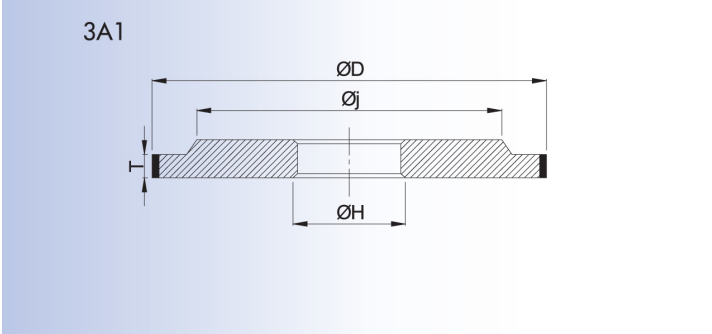
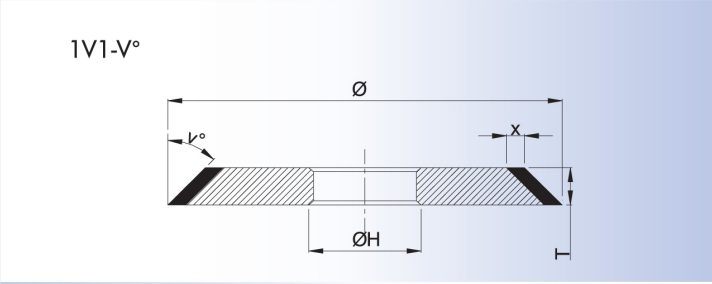
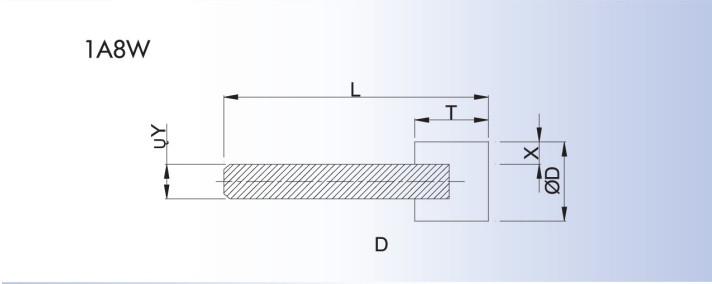
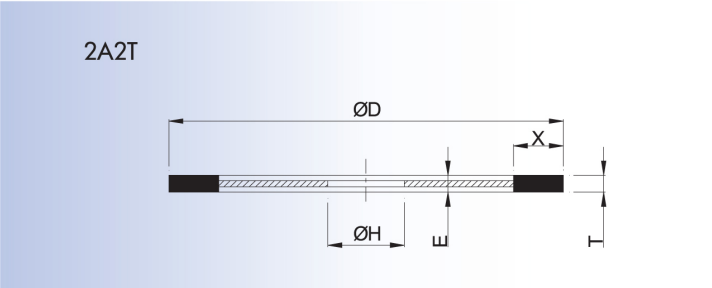
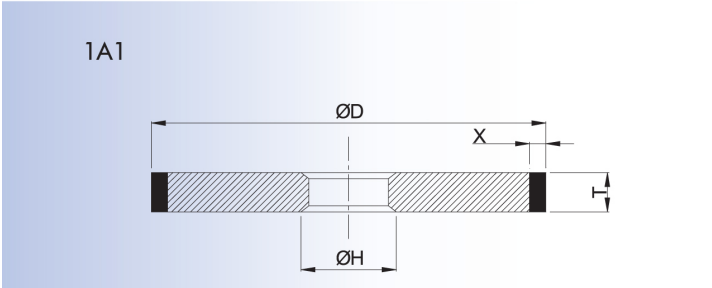
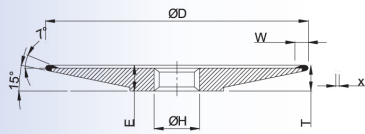

12C9-20°

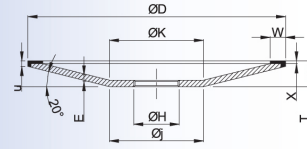

6A2

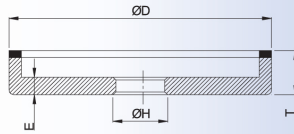

12V9-45°

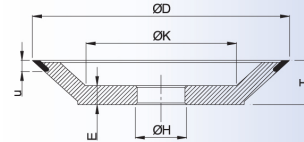

6A9

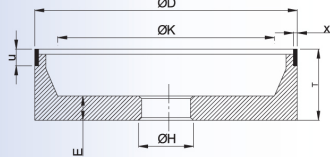

1EE1-V°

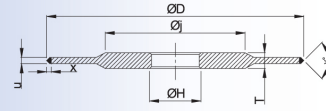

11A2

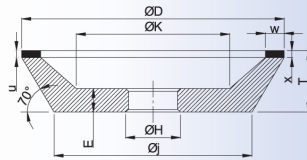

14F1

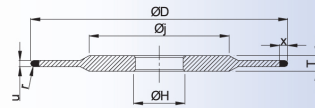

11V9

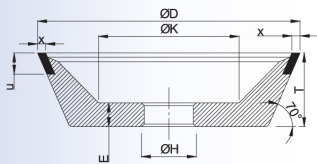

19A2

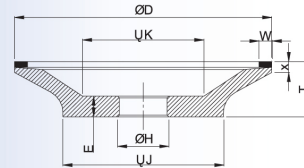

12A2-20°

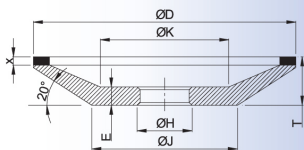

12A2-45°

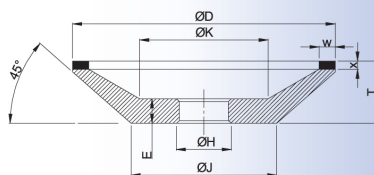

4B19

